

# Tissue Box Guitar

## Materials:

- one empty tissue box per student
- four large rubber bands per student
- one empty paper towel roll per student
- tape
- scissors
- white glue
- markers or crayons
- glitter

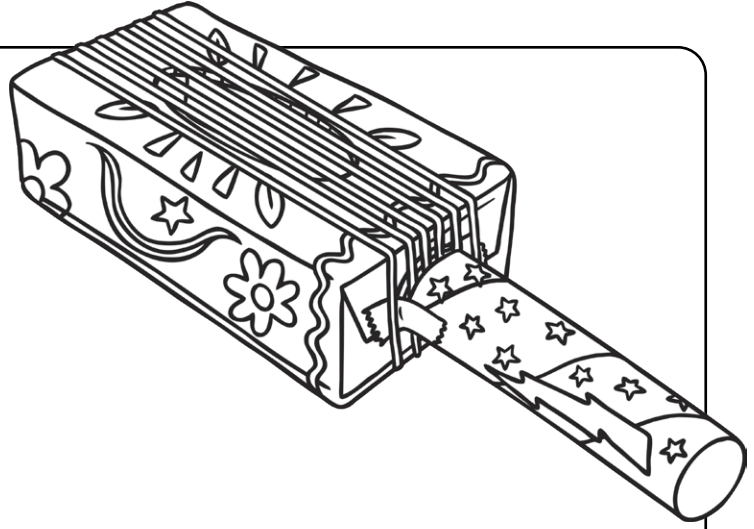

## Instructions:

1. Remove any plastic film from the hole on the tissue box.
2. Have your teacher cut out a hole at one end of the box.
3. Insert a paper towel roll into the hole.  
This will be your guitar neck.
4. Secure the paper towel roll to the tissue box with tape.
5. Add the rubber bands around the tissue box.
6. The rubber bands will lay over the gap of the tissue box.
7. Decorate your guitar using markers or crayons.
8. Add some designs to your guitar using glue and glitter.
9. Allow to dry completely.
10. Play your new guitar!

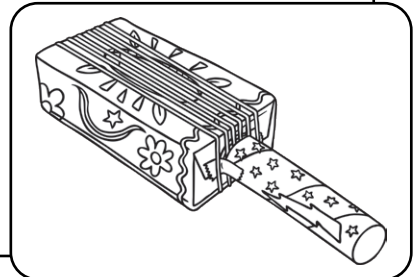
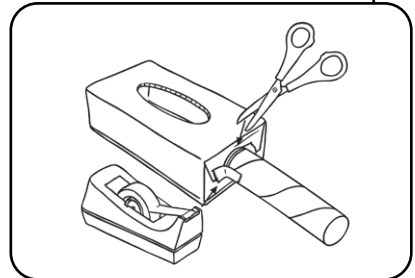
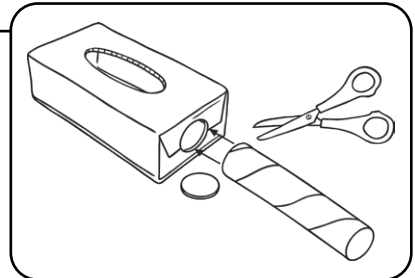



# Sound Reflection Sheet



Write down three observations about sound waves and how your guitar makes sound. Include a sketch or drawing of your observation in the box.

--	--	--

<hr/> <hr/> <hr/> <hr/> <hr/> <hr/> <hr/> <hr/> <hr/> <hr/>	<hr/> <hr/> <hr/> <hr/> <hr/> <hr/> <hr/> <hr/> <hr/> <hr/>	<hr/> <hr/> <hr/> <hr/> <hr/> <hr/> <hr/> <hr/> <hr/> <hr/>
-------------------------------------------------------------	-------------------------------------------------------------	-------------------------------------------------------------

# Tissue Box Guitar

## Materials:

- one empty tissue box per student
- four large rubber bands per student
- one empty paper towel roll per student
- tape
- scissors
- white glue
- markers or crayons
- glitter

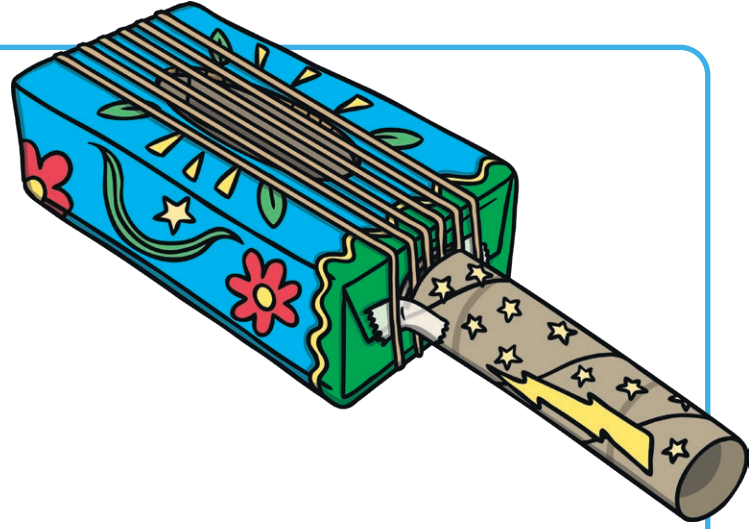

## Instructions:

1. Remove any plastic film from the hole on the tissue box.
2. Have your teacher cut out a hole at one end of the box.
3. Insert a paper towel roll into the hole.  
This will be your guitar neck.
4. Secure the paper towel roll to the tissue box with tape.
5. Add the rubber bands around the tissue box.
6. The rubber bands will lay over the gap of the tissue box.
7. Decorate your guitar using markers or crayons.
8. Add some designs to your guitar using glue and glitter.
9. Allow to dry completely.
10. Play your new guitar!

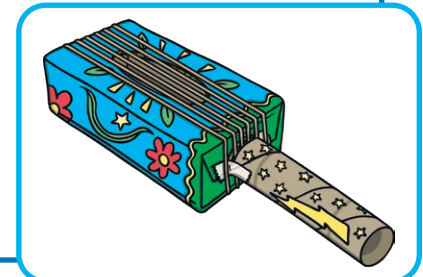
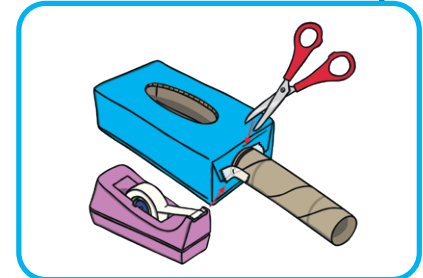
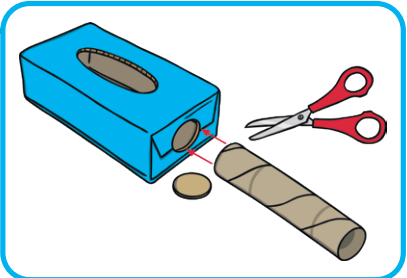



# Sound Reflection Sheet



Write down three observations about sound waves and how your guitar makes sound. Include a sketch or drawing of your observation in the box.

--	--	--

_____	_____	_____
_____	_____	_____
_____	_____	_____
_____	_____	_____
_____	_____	_____
_____	_____	_____
_____	_____	_____
_____	_____	_____

# Craft Resource Disclaimer

---



We hope you find the information on our website and resources useful. This resource refers to the use of scissors. You are responsible for the safe use of these resources, including following any manufacturer's instructions or guidance. We are not responsible for the health and safety of your group or environment and, so, insofar as it is possible under the law, we cannot accept liability for any loss suffered by anyone due to the use of this resource.

# Teacher Guidance

The teacher will cut out a hole to place the paper towel roll. This will serve as the neck of the guitar.